

Scooter Seat User Manual

ninebot[®]

V 1.0

Welcome!

This scooter seat is applicable to Ninebot KickScooter. Enjoy a comfortable ride on your seat.



For aftersales and contact information, please visit www.segway.com for more details.

1 Product and Accessories

① Seat Post Offset and Saddle Kit

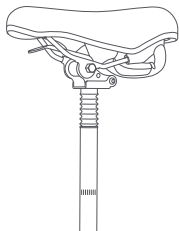

② Foldable Base

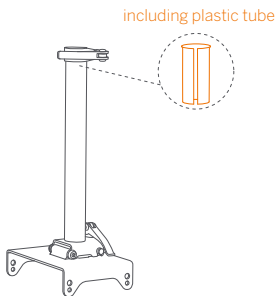

③ Accessories



Screw ×4



Spring Washer ×4



Flat Washer ×4



Plastic Locking Block ×2



Inner Hexagon Wrench ×1



Outer Hexagon Wrench ×1

2 Functional Diagram

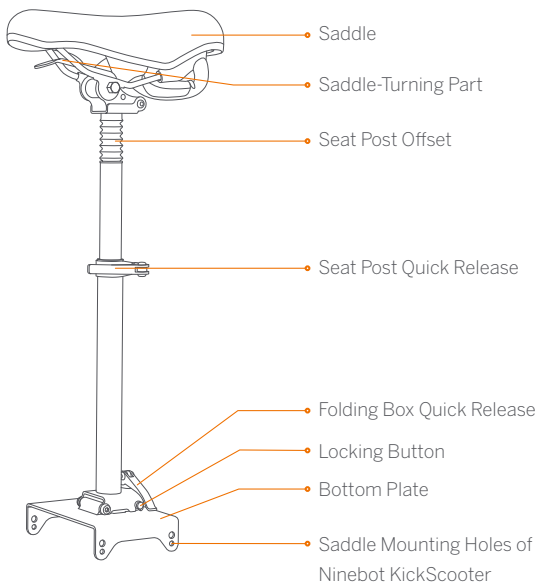

Folding Box Quick Release: to fold or unfold the saddle.

Seat Post Quick Release: to adjust saddle height.

Saddle-Turning Part: pull up to turn the seat cushion.

3 Installation and Usage



Assembly Instruction

① Place the foldable base

Press the locking button; mesh the seat stay and the locking button; lock the folding box quick release; place the base on the back of the scooter.

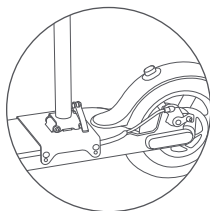
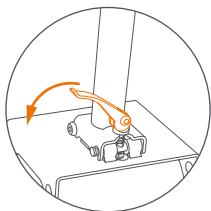
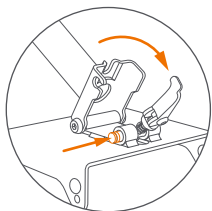

② Lock the screw

Ninebot KickScooter: Place two plastic locking blocks between both sides of the bottom plates and the scooter; mount each hex screw into the saddle mounting hole and pre-tighten (8 rounds) them to fix the plastic locking blocks; tighten the screws in the order shown in the figure.

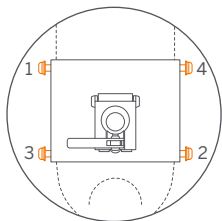

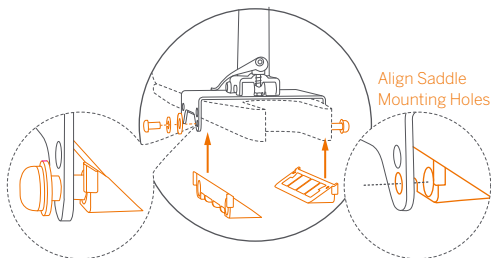

- ⚠️ Align the saddle mounting holes and the recess holes of the two locking blocks; pre-tighten the screws.

③ Mount Seat Post Offset and Saddle Kit

a. Unlock and adjust the seat post quick release.

b. Insert the seat post offset into the plastic tube rotationally; adjust it to proper height; lock the quick release.

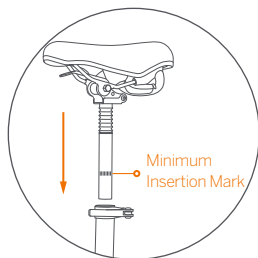
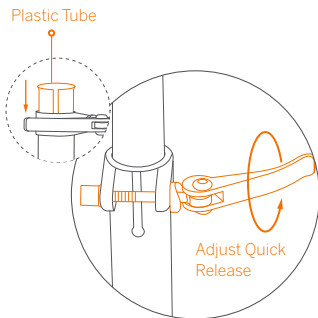

- ⚠️ Make sure that the plastic tube is in the seat post before mounting.

- ⚠️ Don't expose the minimum insertion mark when adjusting height.

④ Adjust Saddle

Adjust the saddle to a proper position and lock it. You can turn and fold the saddle using the saddle-turning part.

⚠ Check whether the saddle is mounted firmly before your ride, and if not, use an outer hexagon wrench to lock the hexagon nut on the turner.

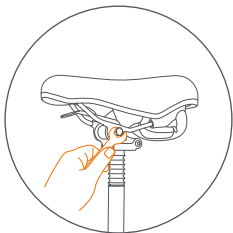
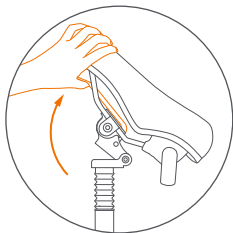

⑤ Ride by sitting

After mounting the saddle, please check whether all the components are mounted firmly (especially two quick releases and screws on the base) and then enjoy a comfortable ride.

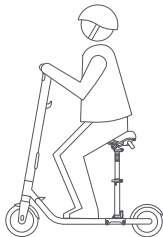

⑥ Fold and Unfold the Saddle

To fold the scooter saddle, unlock the folding box quick release and fold the base.

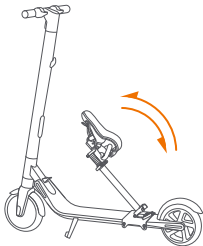

4 Precautions

1. Make sure that the saddle is mounted firmly and the two quick releases are locked before each ride.
2. To fold the scooter, fold the saddle first.
3. The scooter is designed for one rider only.
4. Do not abandon the plastic tube contained in the seat post, otherwise the seat post will sink.
5. The scooter seat cannot be mounted if a pedestal pad has been mounted on a Ninebot KickScooter.

5 Product Information

Item	Scooter Seat for Ninebot KickScooter
Model	PJ05JHZY
Height Adjustment Range	20.1–24.8 inch (51–63 cm)(The height from the ground to the scooter pedestal is not included in that from the scooter pedestal to the top surface of the seat cushion)
Size	8.7 × 10.6 × 26.8 inch (220 × 270 × 680 mm) (Saddle Maximum Height)
Net weight	5.5 lbs (2.5 kg)
Material	Steel, aluminum alloy
Saddle Material	Highly-elastic foam sponge
Saddle Forming	Vacuum forming
Maximum Load	220 lbs (100 kg)
Installation Toolkit	Screw ×4; Spring Washer ×4; Flat Washer ×4; Plastic Locking Block ×2; Inner Hexagon Wrench ; Outer Hexagon Wrench