

User Manual

(Certified Refurbished)

by **SEGWAY**

The manufacturer reserves the right to make changes to the product, release firmware updates, and update this manual at any time. Visit www.segway.com or check the App to download the latest user materials. You must install the App, activate your KickScooter, and obtain the latest updates and safety instructions.

www.segway.com

ninebot[®] KickScooter

ANSI/CAN/UL-2272 certified; ANSI/UL 2271 certified
Visite www.segway.com para baixar o manual do usuário
Original Instructions

Contents

1 Riding Safety	02
2 Packing List	04
3 Diagram	05
4 Assembling Your KickScooter	06
5 Installing a Second Battery Pack	07
6 First Ride	08
7 Charging	09
8 Learning to Ride	09
9 Warnings	11
10 Folding and Carrying	15
11 Maintenance	16
12 Specifications	17
13 Certifications	18
14 Trademark and Legal Statement	20
15 Contact	21

Thanks for choosing the Ninebot KickScooter ES series!

Thanks for choosing the Ninebot KickScooter (hereinafter referred to as KickScooter)!

Your KickScooter is a fashionable transportation device with mobile app, allowing you to connect with other riders.

Enjoy your ride and connect with riders world wide!



▲ WARNING!

Always use both electric brake and foot brake for emergency stopping. Otherwise you risk falls and/or collisions from not achieving the max. braking capability.

1 Riding Safety

1. The KickScooter is a recreational product. Before mastering riding skills, you need to practice. Neither Ninebot Inc. (means Ninebot (Beijing) Tech Co., Ltd. and its subsidiaries and affiliates) nor Segway Inc. is responsible for any injuries or damage caused by a rider's inexperience or failure to follow the instructions in this document.
2. Please understand that you can reduce the risk by following all the instructions and warnings in this manual, but you cannot eliminate all the risks. Remember that whenever you ride the KickScooter you risk injury from loss of control, collisions, and falls. When entering into public spaces always comply with the local laws and regulations. As with other vehicles, faster speeds require longer braking distance. Sudden braking on low traction surfaces could lead to wheel slip, or falls. Be cautious and always keep a safe distance between you and other people or vehicles when riding. Be alert and slow down when entering unfamiliar areas.
3. Always wear a helmet when riding. Use an approved bicycle or skateboard helmet that fits properly with the chin strap in place, and provides protection for the back of your head.
4. Do not attempt your first ride in any area where you might encounter children, pedestrians, pets, vehicles, bicycles, or other obstacles and potential hazards.
5. Respect pedestrians by always yielding the right of way. Pass on the left whenever possible. When approaching a pedestrian from the front, stay to the right and slow down. Avoid startling pedestrians. When approaching from behind, announce yourself and slow down to walking speed when passing. Please obey local traffic laws and regulations if situation is different.
6. In places without laws comply with the safety guidelines outlined in this manual. Neither Ninebot Inc. nor Segway Inc. is responsible for any property damage, personal injury/death, accidents, or legal disputes caused by violations of the safety instructions.
7. Do not allow anyone to ride your KickScooter on his/her own unless they have carefully read this manual and followed the New Rider Tutorial in the App. The safety of new riders is your responsibility. Assist new riders until they are comfortable with the basic operation of the KickScooter. Make sure each new rider wears a helmet and other protective gear.
8. Before each ride check for loose fasteners and damaged components. If the KickScooter makes abnormal sounds or signals an alarm, immediately stop riding. Diagnose your KickScooter via the Segway-Ninebot App and call your dealer/distributor for service.
9. Be alert! Scan both far ahead and in front of your KickScooter — your eyes are your best tool for safely avoiding obstacles and low traction surfaces (including, but not limited to, wet ground, loose sand, loose gravel, and ice).
10. To reduce risk of injury, you must read and follow all "CAUTION" and "WARNING" notices in this document. Do not ride at an unsafe speed. Under no circumstance should you ride on roads with motor vehicles. The manufacturer recommends riders be 14+ years

old. Always follow these safety instructions:

- A. People who should not ride the KickScooter include:
 - i. Anyone under the influence of alcohol or drugs.
 - ii. Anyone who suffers from disease that puts them at risk if they engage in strenuous physical activity.
 - iii. Anyone who has problems with balance or with motor skills that would interfere with their ability to maintain balance.
 - iv. Anyone whose weight is outside the stated limits (see Specifications).
 - v. Pregnant women.
 - B. Riders under the age of 18 years old should ride under adult supervision.
 - C. Comply with local laws and regulations when riding this product. Do not ride where prohibited by local laws.
 - D. To ride safely, you must be able to clearly see what is in front of you and you must be clearly visible to others.
 - E. Do not ride in the snow, in the rain, or on roads which are wet, muddy, icy, or that are slippery for any reason. Do not ride over obstacles (sand, loose gravel, or sticks). Doing so could result in a loss of balance or traction and could cause a fall.
11. Do not attempt to charge your KickScooter if it, the charger, or the power outlet is wet.
 12. As with any electronic device, use a surge protector when charging to help protect your KickScooter from damage due to power surges and voltage spikes. Only use the Segway supplied charger. Do not use a charger from any other different product models.
 13. Use only Ninebot or Segway approved parts and accessories. Do not modify your KickScooter. Modifications to your KickScooter could interfere with the operation of the KickScooter, could result in serious injury and/or damage, and could void the Limited Warranty.

2 Packing List

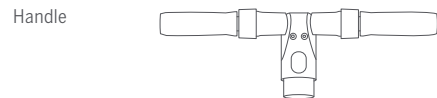

User Materials



Second Battery Pack

	ES1	ES2	ES4
	Sold separately	Included	

Accessories

M5 Flathead Screw x 5
(one extra)



3mm Hex Wrench



Battery Charger

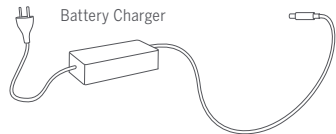

When unboxing your KickScooter, please verify that the above items are included in the package. If you are missing any components, please contact your dealer/distributor or nearest service center (see contacts in the user manual). After verifying that all components are present and in good condition, you can assemble your new KickScooter.

Please retain the box and packaging materials in case you need to ship your KickScooter in the future.

Remember to power off your KickScooter and unplug the charge cable before assembling, mounting accessories, or cleaning the mainframe.

3 Diagram

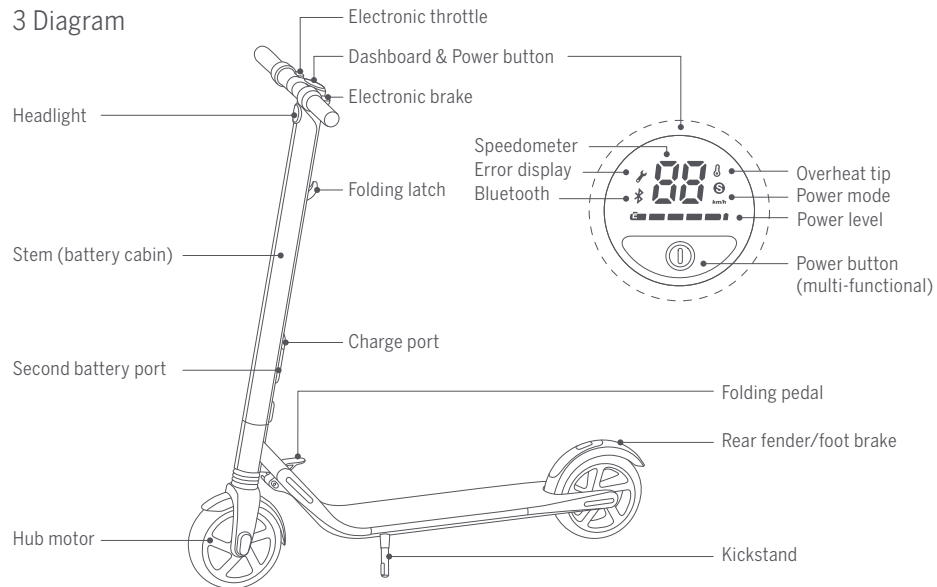

Dashboard & Power Button

Speedometer: Indicates the current speed. Also displays error codes when faults are detected. When the scooter fails, the speedometer displays error code.

Power level: Indicates the remaining battery level with 5 bars. Each bar equates to approximately 20% power level.

Power mode (double click the power button to switch the mode):

—Red "S" icon: Sport mode (maximum power/speed and reduced range).

—White "S" icon: Standard mode (moderate power/speed and range).

—No "S" icon: Speed limit mode (minimum power/speed and increased range).

Bluetooth: A blinking Bluetooth icon indicates that the vehicle is ready to connect. A solid Bluetooth icon indicates that the vehicle is connected to a mobile device.

Power button: Short press to power on. Long press to power off. When powered on, single click to turn on/off the headlight. Double-click to change power mode.

Overheat tip: The thermometer icon always on indicates that the battery temperature has reached 50 °C. At this point, the vehicle cannot accelerate normally and may not be charged. Do not use it until the temperature is lowered to normal range.

Error display: The lit wrench icon indicates the scooter error.

4 Assembling Your KickScooter

1. Unfold the stem and push it until you hear a click. Then unfold the kickstand to support the scooter.

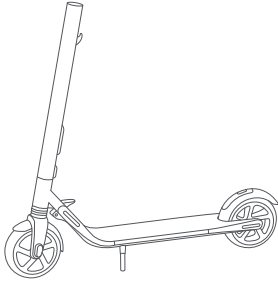

3. Install four screws (two on each side) with the included hex wrench.

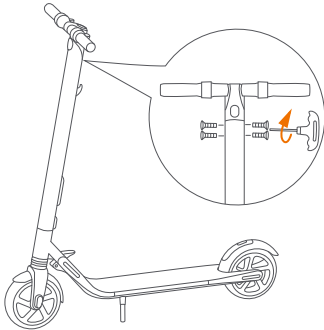

2. Firmly connect the wires inside the handle and the stem. Slide the handle onto the stem. Be aware of the correct orientation.

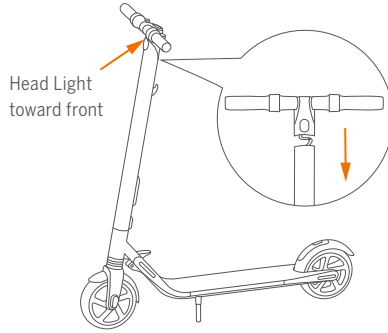

4. Verify that your KickScooter powers on and off.

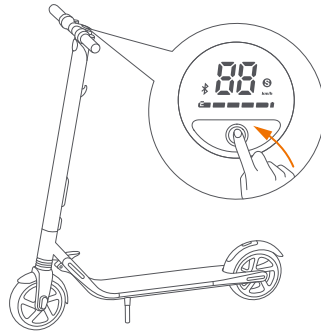

5 Installing a Second Battery Pack ⚠ Warning: please use the screws provided with this product only.

Follow these steps when installing a second battery pack:

1. Remove the three screws on the stem, as shown. Then remove the cover near the charge port.

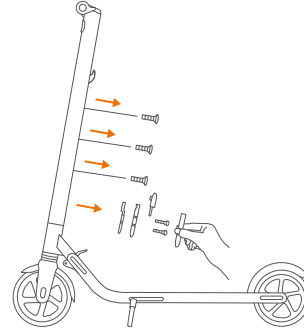

3. Install the external battery on the rail and fix it with the M4 (20mm) screws (2 pcs), provided with this product. After they are properly installed, block the screw holes with the rubber stopper.

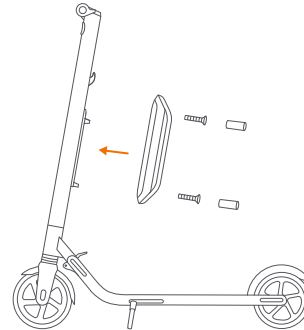

2. Install the rail with the M4 (10mm) screws (3 pcs), provided with this product. Please make sure it is properly fixed.

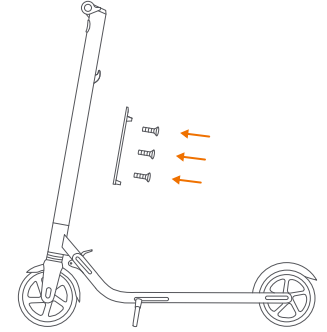

4. Verify that your KickScooter powers on and off.

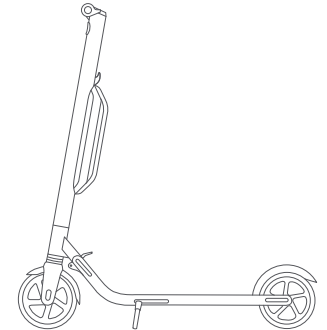

6 First Ride

⚠ There are safety risks when learning to ride the KickScooter. You must read the Safety Instructions via the App before your first ride.

For your safety, your new KickScooter is not activated and will beep occasionally after Power ON.

Until activated, the KickScooter maintains a very low riding speed, and can not be ridden with full function. Install the App on your mobile device (with Bluetooth 4.0 or above), connect to the KickScooter with Bluetooth, and follow the App instructions to activate your KickScooter and enjoy the full performance.

Scan the QR code to download the App (iOS 8.0 or above, Android™ 4.3 or above).



- 1 Install the App and register/login.

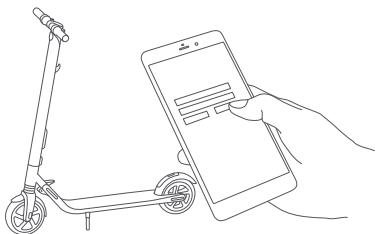

- 2 Power on the KickScooter. A blinking Bluetooth icon indicates the KickScooter is waiting for a connection.

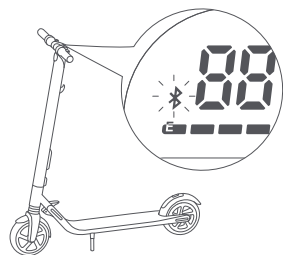

- 3 Click "Vehicle" → "Scan for Vehicle" to connect to your KickScooter. The KickScooter will beep when the connection is successful. The Bluetooth icon will stop blinking and remain illuminated.

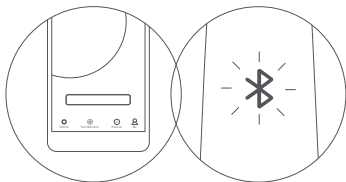

- 4 Follow the App instructions to activate the KickScooter and learn how to ride safely. You can now start to use your KickScooter, check the status with App, and interact with other users. Have fun!

7 Charging

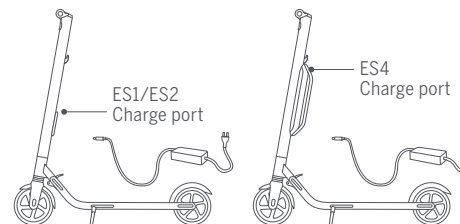

Charging step tips



Open the charge port cover.

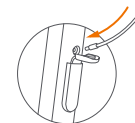

Insert the charge plug.

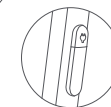

Close the charge port cover when finished.

⚠ WARNING

Do not connect the charger if the charge port or charge cable is wet. Do not charge or use your battery if it is damaged or see trace of water.

Your KickScooter is fully charged when the LED on the charger changes from red (charging) to green (trickle charge). Close the charge port cover when not charging.

8 Learning to Ride



Wear an approved helmet and other protective gear to minimize any possible injury.

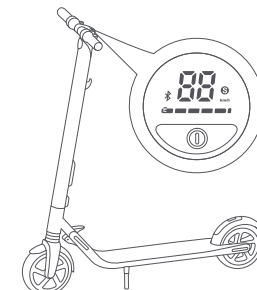

1. Power on the scooter and check the indicator lamp power level. Charge the scooter if the battery level is low.

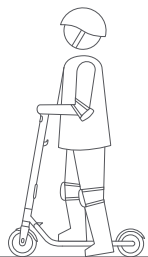

2. Stand on the footrest with one foot and push off with your foot to start gliding.

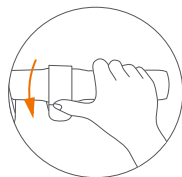

3. Put your other foot on the footrest to keep both feet stable. Press the throttle on right hand to speed up when you are balanced.

Note. For your safety, the motor will not engage until the scooter reaches 1.8 mph (3 km/h).

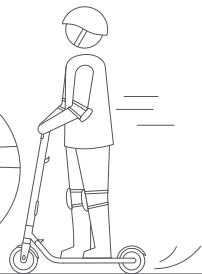
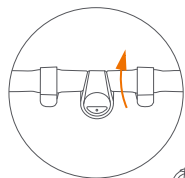

4. Slow down by releasing the throttle; stir the brake handle thumb shifter quickly and stamp the fender with foot at the same time to trigger mechanical braking in order to make a sharp brake.

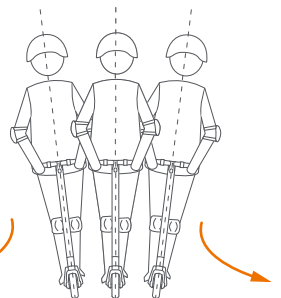

5. To turn, shift your body weight and turn the handle slightly.

⚠ WARNING

When braking rapidly you risk serious injury due to loss of traction and falls. Maintain a moderate speed and look out for potential hazards.

9 Warnings

⚠ WARNING

Failure to follow these instructions could lead to serious injury.



⚠ DO NOT ride the scooter in the rain.

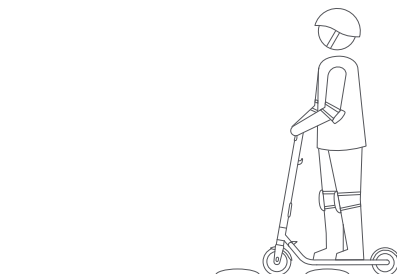

⚠ DO NOT ride over speed bumps, thresholds, or other bumps at HIGH SPEED.

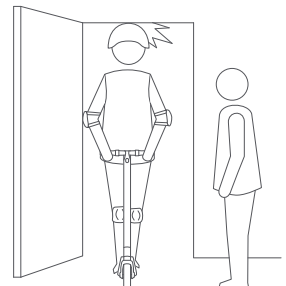

⚠ Watch your head when passing through doorways.

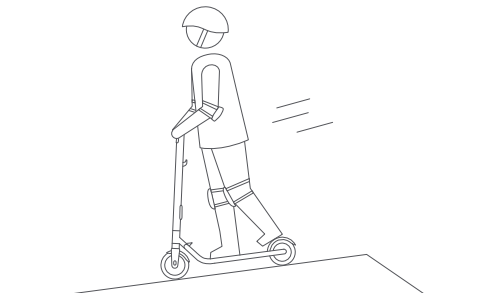

⚠ Watch your speed when traveling downhill. Use both brakes together when traveling at high speed.

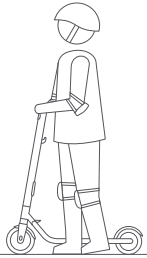
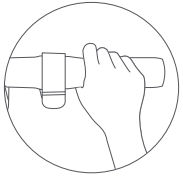

! DO NOT press the throttle when walking with the scooter.

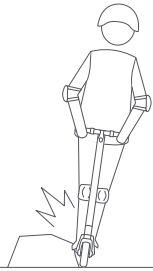

! Avoid contacting obstacles with the tire/wheel.

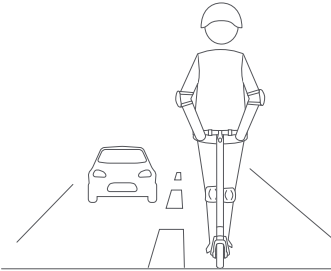

! DO NOT ride on public roads, motorways, or highways.

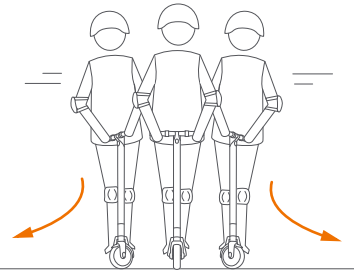

! DO NOT rotate the handle violently while driving at high speed.

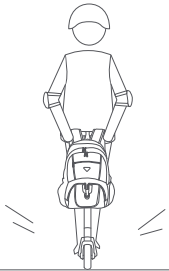

! DO NOT carry heavy objects on the handlebar.

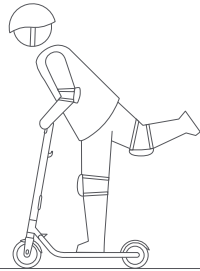

! DO NOT ride the scooter with only one foot.



! DO NOT ride through puddles or other bodies of water deeper than 1 inch (2 cm).

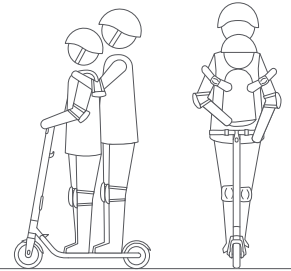

! The KickScooter is for one rider only. Do not ride double or carry any passengers. Do not carry a child.

10 Folding and Carrying

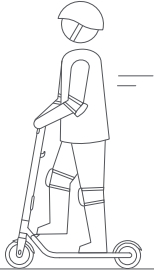

⚠ DO NOT step on the folding pedal while riding.

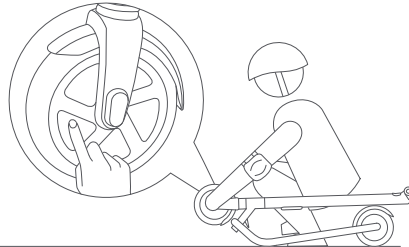

⚠ DO NOT touch the hub motor after riding because it can get hot.

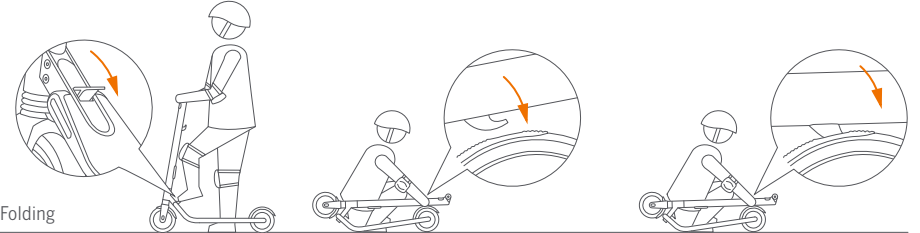

Folding

Step on the folding pedal while pushing the handlebar forward slightly. Then fold the handlebar down until it locks into the rear fender.



⚠ DO NOT take your hands off the handlebar while riding. Do not ride with one hand only.

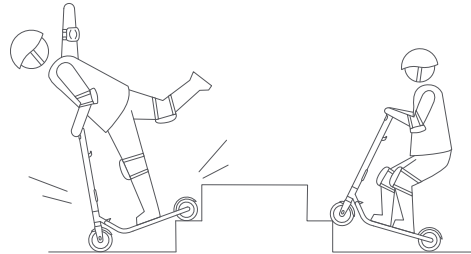

⚠ DO NOT ride up and down stairs or jump over obstacles.

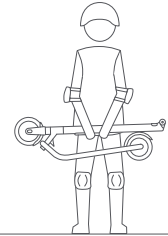
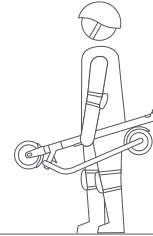

Carrying

When your KickScooter is folded up, simply lift it by the stem to carry.

⚠ WARNING
Always keep both hands on the handlebar or you risk serious injury due to loss of balance and falls.

11 Maintenance

Cleaning and Storage

Use a soft, wet cloth to wipe the mainframe clean. Hard to remove dirt can be scrubbed with a toothbrush and toothpaste, then cleaned with a soft, wet cloth.

NOTE

Do not wash your KickScooter with alcohol, gasoline, acetone, or other corrosive/volatile solvents. These substances may damage the appearance and internal structure of your KickScooter. Do not wash your KickScooter with a power washer or hose.

WARNING

Make sure the KickScooter is powered OFF, the charging cable is unplugged, and the rubber cap on the charge port is tightly sealed before cleaning; otherwise you may damage the electronic components.

Store your KickScooter in a cool, dry place. Do not store it outdoors for extended periods of time. Exposure to sunlight and temperature extremes (both hot and cold) will accelerate the aging process of the plastic components and may reduce battery life.

Battery Pack Maintenance

Do not store or charge the battery at temperatures outside the stated limits (see Specifications). Do not puncture the battery. Refer to your local laws and regulations regarding battery recycling and/or disposal.

A well maintained battery can perform well even after many miles of riding. Charge the battery after each ride and avoid draining the battery completely. When used at room temperature (70°F [22°C]) the battery range and performance is at its best; whereas using it at temperatures below 32°F (0°C) can decrease range and performance. Typically, at -4°F (-20°C) range can be half that of the same battery at 70°F (22°C). Battery range will recover when temperature rises. More details are available in the App.

NOTE

Typically, a fully charged battery should retain charge for 120-180 days in Standby Mode. A low-power battery should retain charge for 30-60 days in Standby Mode. Remember to charge the battery after each use. Completely draining the battery may cause permanent damage to the battery. Electronics inside the battery record the charge-discharge condition of the battery; damage caused by over-discharge or under-discharge will not be covered by the Limited Warranty.

WARNING

Do not charge or use your battery if it is damaged or see trace of water. Do not attempt to disassemble the battery. Risk of fire. No user serviceable parts.

WARNING

Do not ride when the ambient temperature is outside the machine operation temperature (see Specifications) because low/high temperature will limit the maximum power/torque. Doing so could cause personal injury or property damage due to slips or falls.

12 Specifications

	Item	ES1	ES2	ES4
Dimensions	Unfold: Length x Width x Height	40x17x45 in (102x43x113 cm)		
	Fold: Length x Width x Height	45x17x13 in (113x43x32 cm)		
Weight	Net	24.9 lbs (11.3 kg)	27.6 lbs (12.5 kg)	30.9 lbs (14.0 kg)
	Payload	55–220 lbs (25–100 kg)		
Rider	Recommended Age	14+ years		
	Required Height	3' 11"–6' 6" (120–200 cm)		
	Max. Speed	12.4 mph (20 km/h)	15.5 mph (25 km/h)	18.6 mph (30 km/h) ^[3]
Machine Parameters	Typical Range ^[1]	15.5 miles (25 km)	15.5 miles (25 km)	28.0 miles (45 km)
	Max. Slope	10%	10%	15%
	Traversable Terrain	asphalt/flat pavement; obstacles < 0.4 in (1 cm); gaps < 1.2 in (3 cm)		
	Operating Temperature	14–104°F (-10–40°C)		
	Storage Temperature	-4–122°F (-20–50°C)		
	IP Rating	IP54		
	Battery	Nominal Voltage	36 VDC	
Max. Charging Voltage		42 VDC		
Charging Temperature		32–104°F (0–40°C)		
Nominal Capacity		187 Wh	187 Wh	374 Wh
Battery Management System		Over-heating, short circuit, over-current and over-charge protection		
Number Of Batteries ^[2]		1	1	2
Motor	Nominal Power	250 W	300 W	300 W
	Output Power	71 W		
Charger	Input Voltage	100-240 VAC		
	Output Voltage	42 VDC		
	Output Current	1.7 A		
	Duration of Charging	3.5 h	3.5 h	7 h
	Shock Absorber	front	front & rear	
Features	Brake Light	reflector	LED rear light	
	Atmosphere Light	N/A	Customizable colour	
	Riding Modes	Speed limit mode, Standard mode and Sport mode		

[1] Typical Range: tested while riding under full power, 165 lbs (75 kg) load, 77°F (25°C), 60% of max. speed on average on pavement.

[2] All KickScooter models could install the second battery. Some of the parameters would change in this case.

[3] According to relevant requirements of Korean Certifications, the maximum speed of ES series products sold in South Korea should not exceed 15.5 mph (25km/h).

13 Certifications

This product is certified to ANSI/CAN/UL-2272 by CSA.

The batteries comply with UN/DOT 38.3.

The second battery pack complies with ANSI/UL 2271.

Federal Communications Commission (FCC) Compliance Statement for USA

This device complies with part 15 of the FCC rules. Operation is subject to the following two conditions: (1) This device may not cause harmful interference, and (2) this device must accept any interference received, including interference that may cause undesired operation.

NOTE

This equipment has been tested and found to comply with the limits for a Class B digital device, pursuant to part 15 of the FCC Rules. These limits are designed to provide reasonable protection against harmful interference in a residential installation. This equipment generates, uses and can radiate radio frequency energy and, if not installed and used in accordance with the instructions, may cause harmful interference to radio communications. However, there is no guarantee that interference will not occur in a particular installation. If this equipment does cause harmful interference to radio or television reception, which can be determined by turning the equipment off and on, the user is encouraged to try to correct the interference by one or more of the following measures:

- Reorient or relocate the receiving antenna.
- Increase the separation between the equipment and receiver.
- Connect the equipment into an outlet on a circuit different from that to which the receiver is connected.
- Consult the dealer or an experienced radio/TV technician for help.

This equipment complies with FCC radiation exposure limits set forth for an uncontrolled environment.

Industry Canada (IC) Compliance Statement for Canada

This device complies with Industry Canada license-exempt RSS standard (s). Operation is subject to the following two conditions: (1) this device may not cause interference, and (2) this device must accept any interference, including interference that may cause undesired operation of the device.

CAN ICES-3 (B)/NMB-3(B)

Neither Segway Inc. nor Ninebot is responsible for any changes or modifications not expressly approved by Segway Inc. or Ninebot. Such modifications could void the user's authority to operate the equipment.

For model: ES1/ES2/ES4

FCC ID: 2ALS8-NT9527

IC: 22636-NT9527

European Union Compliance Statement

Battery recycling information for the European Union



Batteries or packaging for batteries are labeled in accordance with European Directive 2006/66/EC concerning batteries and accumulators and waste batteries and accumulators. The Directive determines the framework for the return and recycling of used batteries and accumulators as applicable throughout the European Union. This label is applied to various batteries to indicate that the battery is not to be thrown away, but rather reclaimed upon end of life per this Directive.

In accordance with the European Directive 2006/66/EC, batteries and accumulators are labeled to indicate that they are to be collected separately and recycled at end of life. The label on the battery may also include a chemical symbol for the metal concerned in the battery (Pb for lead, Hg for mercury, and Cd for cadmium). Users of batteries and accumulators must not dispose of batteries and accumulators as unsorted municipal waste, but use the collection framework available to customers for the return, recycling, and treatment of batteries and accumulators. Customer participation is important to minimize any potential effects of batteries and accumulators on the environment and human health due to the potential presence of hazardous substances.

Restriction of Hazardous Substances (RoHS) Directive

This Ninebot (Changzhou) Tech Co., Ltd. product, with included parts (cables, cords, and so on) meets the requirements of Directive 2011/65/EU on the restriction of the use of certain hazardous substances in electrical and electronic equipment ("RoHS recast" or "RoHS 2").

Radio Equipment Directive



Segway Europe B.V.

EU Contact Address for regulatory topics only: Hogehilweg 8, 1101CC Amsterdam, The Netherlands.

Hereby, Ninebot (Changzhou) Tech Co., Ltd. declares that the wireless equipment listed in this section are in compliance with the essential requirements and other relevant provisions of Directive 2014/53/EU.

14 Trademark and Legal Statement

Ninebot is the registered trademark of Ninebot (Tianjin) Tech. Co., Ltd; Segway and the Rider Design are the registered trademarks of Segway Inc.; Android, Google Play are trademarks of Google Inc., App Store is a service mark of Apple Inc., The respective owners reserve the rights of their trademarks referred to in this manual.

The KickScooter is covered by relevant patents. For patent information go to <http://www.segway.com>.

We have attempted to include descriptions and instructions for all the functions of the KickScooter at the time of printing. However, due to constant improvement of product features and changes of design, your KickScooter may differ slightly from the one shown in this document. Visit the Apple App Store (iOS) or the Google Play Store (Android) to download and install the App.

Please note that there are multiple Segway and Ninebot models with different functions, and some of the functions mentioned herein may not be applicable to your unit. The manufacturer reserves the right to change the design and functionality of the KickScooter product and documentation without prior notice.

© 2019 Ninebot (Beijing) Tech Co. Ltd. All rights reserved.

15 Contact

Contact us if you experience issues relating to riding, maintenance and safety, or errors/faults with your KickScooter.

Americas:

Segway Inc.

14 Technology Drive, Bedford, NH 03110, USA

Tel : 1-603-222-6000

Fax: 1-603-222-6001

Toll Free: 1-866-473-4929

E-mail Sales: customeroperation@segway.com

E-mail Service: technicalsupport@segway.com

Website: www.segway.com

Europe, Middle East and Africa:

Segway Europe B.V.

Hogehilweg 8, 1101CC Amsterdam, The Netherlands

Website: www.segway.com

Have your KickScooter serial number on hand when contacting Segway.

You can find your serial number on the underside of your KickScooter or in the App under More Settings -> Basic Information.